

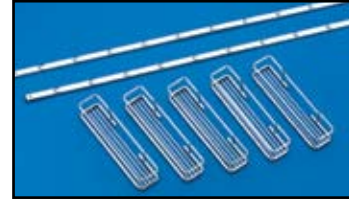

WOW! That's the general reaction from people introduced to the Chef's Roll-Out Pantry. This state-of-the-art organizer features a swing-out frame with 20 large interior chrome baskets, pivot-sliding hardware, 2 sets of door storage standards and 10 door mount baskets with fasteners.



Small Door Storage Basket

Height: 2³/₈" (61 mm)
 Depth: 2³/₄" (70 mm)
 Width: 12³/₈" (315 mm)



Large Pantry Basket

Height: 3" (76 mm)
 Depth: 7⁷/₈" (200 mm)
 Width: 14¹⁵/₁₆" (380 mm)

TALL & PANTRY ACCESSORIES
Premiere
 Cabinet Accessories

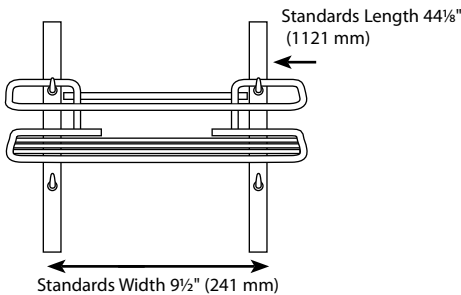

TOP VIEW

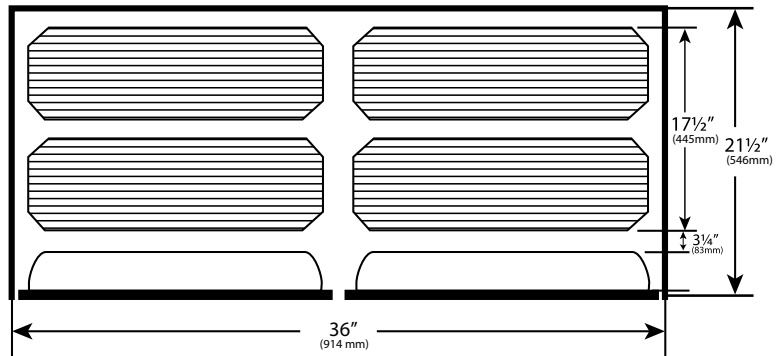

PRODUCT #s	DESCRIPTION	PRODUCT DIMENSIONS	FINISH	SET PER CARTON	WEIGHT PER CARTON	SUGGESTED LIST PRICE
Chef's Pantry and Door Storage						Individual Pack
5222-21 CR	Chef's Roll-Out Pantry	34" (864 mm) W x 21 ¹ / ₂ " (546 mm)D x 49 ¹ / ₄ "-52 ¹ / ₄ " (1251-1315 mm)H	Chrome	1	162 lbs.	\$2,895.50
Door Storage Only						Individual Pack
5222-DS CR	5 Door Storage Baskets and 2 Standards	12 ³ / ₈ " (315 mm) W x 2 ³ / ₄ " (70 mm)D x 2 ³ / ₈ " (61 mm)H 44 ¹ / ₈ " (1121 mm)L	Chrome	1	15 lbs.	\$294.20

CONTAINS:

5222-21 CR - Chrome plated pantry frame with all pivot and mounting hardware. (20) large interior baskets, (10) small door baskets, and 2 sets of 44" long door mount brackets.

5222-DS CR - (5) Chrome plated door storage baskets, (2) standards and (4) screws

NOTE:

Chef's Pantry and Door Storage is available in chrome only. 220# Weight Capacity. **Ship by truck**

5200 CR SERIES

CHROME PULL-OUT PANTRY

Enhance functionality and preserve a stylish image with the Chrome Pull-Out Pantry. The 5200 CR Series is available in a plentiful selection of sizes and is designed on the 450 lbs. rated slide system for a quiet glide out function. This Premiere accessory features micro-adjustment door mounting brackets and top and bottom slide covers for a finished look. The chrome pull-out pantries are kit packaged with frame, baskets and door mounting brackets in one carton.



5200 Series Chrome Pull-Out Pantry

TALL & PANTRY
ACCESSORIES

Premiere
Cabinet Accessories

Another Rev-A-Shelf Innovation ... Double Soft-Close Slides!

Even with the most heavy loads our pantries will shut softly with our Heavy-Duty Soft-Close slide system, developed and manufactured exclusively for Rev-A-Shelf by:



Lower Soft-Close Slide



Upper Soft-Close Slide

5200 SERIES

SPECIFICATIONS

Series	Frame Height	Depth	# of Baskets	# of Door Mount Brackets	Net Minimum Width:			
					-09	-14	-16	-20
5225	26-3/8-35" 670-890 mm	20" 508 mm	3	2	8-7/8" 226 mm	14-3/4" 375 mm	16-3/4" 426 mm	20-5/8" 524 mm
5243	43-3/8-50-3/4" 1102-1289 mm	20" 508 mm	4	2	8-7/8" 226 mm	14-3/4" 375 mm	n/a	20-5/8" 524 mm
5250	50-3/4-58-1/4" 1289-1480 mm	20" 508 mm	4	2	8-7/8" 226 mm	14-3/4" 375 mm	n/a	20-5/8" 524 mm
5258	58-1/4-65-3/4" 1480-1670 mm	20" 508 mm	5	3	8-7/8" 226 mm	14-3/4" 375 mm	n/a	20-5/8" 524 mm
5273	73-5/8-80-3/4" 1870-2051mm	20" 508 mm	6	4	8-7/8" 226 mm	14-3/4" 375 mm	n/a	20-5/8" 524 mm

Individual Baskets Dimensions:

Width = Net Minimum Width from chart

Depth = 17-1/4" (438 mm), Height = 3" (77 mm)



Door mounting brackets feature micro adjustment. *Included with all pantries.*

Door Mount Bracket Hole Spread

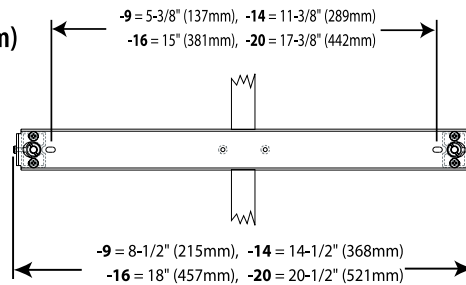

Door Mount Bracket Overall Width

These products come with built-in door mount brackets.

If the hole spread aligns with a thin, delicate, or seamed area of your cabinet, use part 5200-DM-KIT-52 (sold separately) to ensure mounting to the thick portion of your door.

PRODUCT #s	Description	Basket Width	Frame Height	Overall Depth	FINISH	SET PER CARTON	WEIGHT PER CARTON	SUGGESTED LIST PRICE
Base Cabinet "SHORTY" Pull-Out Pantry								
Individual Pack								
5225-09 CR	3 Baskets/2 Door Mount Brackets	8 7/8" (226 mm)	26 3/8"-35" (670-890 mm)	20" (508 mm)	Chrome	1	32 lbs.	\$849.85
5225-14 CR	3 Baskets/2 Door Mount Brackets	14 3/4" (375 mm)	26 3/8"-35" (670-890 mm)	20" (508 mm)	Chrome	1	36 lbs.	\$874.05
5225-16 CR	3 Baskets/2 Door Mount Brackets	16 3/4" (426 mm)	26 3/8"-35" (670-890 mm)	20" (508 mm)	Chrome	1	37 lbs.	\$911.20
5225-20 CR	3 Baskets/2 Door Mount Brackets	20 5/8" (524 mm)	26 3/8"-35" (670-890 mm)	20" (508 mm)	Chrome	1	39 lbs.	\$941.65
Utility Cabinet Pull-Out Pantry								
Individual Pack								
5243-09N CR	4 Baskets/2 Door Mount Brackets	8 7/8" (226 mm)	43 3/8"-50 3/4" (1102-1289 mm)	20" (508 mm)	Chrome	1	39 lbs.	\$925.40
5243-14N CR	4 Baskets/2 Door Mount Brackets	14 3/4" (375 mm)	43 3/8"-50 3/4" (1102-1289 mm)	20" (508 mm)	Chrome	1	44 lbs.	\$989.35
5243-20N CR	4 Baskets/2 Door Mount Brackets	20 5/8" (524 mm)	43 3/8"-50 3/4" (1102-1289 mm)	20" (508 mm)	Chrome	1	49 lbs.	\$1,052.25
5250-09 CR	4 Baskets/2 Door Mount Brackets	8 7/8" (226 mm)	50 3/4"-58 1/4" (1289-1480 mm)	20" (508 mm)	Chrome	1	44 lbs.	\$1,000.80
5250-14 CR	4 Baskets/2 Door Mount Brackets	14 3/4" (375 mm)	50 3/4"-58 1/4" (1289-1480 mm)	20" (508 mm)	Chrome	1	50 lbs.	\$1,085.35
5250-20 CR	4 Baskets/2 Door Mount Brackets	20 5/8" (524 mm)	50 3/4"-58 1/4" (1289-1480 mm)	20" (508 mm)	Chrome	1	62 lbs.	\$1,168.40
5258-09 CR	5 Baskets/3 Door Mount Brackets	8 7/8" (226 mm)	58 1/4"-65 3/4" (1480-1670 mm)	20" (508 mm)	Chrome	1	48 lbs.	\$1,076.05
5258-14 CR	5 Baskets/3 Door Mount Brackets	14 3/4" (375 mm)	58 1/4"-65 3/4" (1480-1670 mm)	20" (508 mm)	Chrome	1	57 lbs.	\$1,179.15
5258-20 CR	5 Baskets/3 Door Mount Brackets	20 5/8" (524 mm)	58 1/4"-65 3/4" (1480-1670 mm)	20" (508 mm)	Chrome	1	65 lbs.	\$1,288.20
5273-04 CR	6 Baskets/4 Door Mount Brackets	4" (100mm)	73 3/8" - 80 3/4" (1870-2051 mm) H	20" (508 mm)	Chrome	1	48 lbs.	\$1,146.95
5273-09 CR	6 Baskets/4 Door Mount Brackets	8 7/8" (226 mm)	73 3/8" - 80 3/4" (1870-2051 mm)	20" (508 mm)	Chrome	1	66 lbs.	\$1,237.85
5273-14 CR	6 Baskets/4 Door Mount Brackets	14 3/4" (375 mm)	73 3/8" - 80 3/4" (1870-2051 mm)	20" (508 mm)	Chrome	1	75 lbs.	\$1,369.95
5273-20 CR	6 Baskets/4 Door Mount Brackets	20 5/8" (524 mm)	73 3/8" - 80 3/4" (1870-2051 mm)	20" (508 mm)	Chrome	1	82 lbs.	\$1,515.10
5200-DM-KIT-52	Door Mount Extenders (one pair)				Silver Epoxy	1	1 lbs.	\$63.80

NOTE: All pantry kits are packaged with frame, baskets, and door mounting brackets in one carton. 450# rated Full-Extension slides. Ship by truck. (See above for more information.) Baskets are adjustable, first basket mounts on top of the slide, 6" (152 mm) from floor, holes then available every 4" (102 mm) above that.

TALL & PANTRY
ACCESSORIES

Premiere
Cabinet Accessories

These pantry sets include 5 polymer shelves with an independent rotating system. The shelves are available in 18", 20" or 24" diameters. Available in white or almond color.



TALL & PANTRY
ACCESSORIES

REV-A-SHELF
Accessible Storage



6221 - 20"

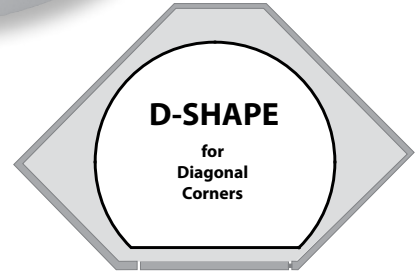

6421 - 18" & 24"

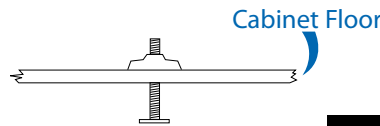
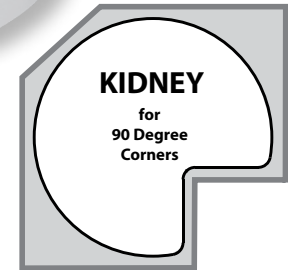

Jack Screw included
in all 5 shelf sets

Special Order Items
Please allow two-week lead time.

PRODUCT #'s	DESCRIPTION	PRODUCT DIMENSIONS	FINISH	SET PER CARTON	WEIGHT PER CARTON	SUGGESTED LIST PRICE
5 Shelf Pantry Sets and Rotating Hardware, Shaft Sold Separately						Individual Pack
6265-20-**-50	5 Shelf D-Shape Set (no post)	20" (508 mm) Diameter	Polymer Trays	1	20 lbs.	\$290.15
6465-18-**-50	5 Shelf Kidney Shape Set (no post)	18" (457 mm) Diameter	Polymer Trays	1	22 lbs.	\$280.85
6465-24-**-50	5 Shelf Kidney Shape Set (no post)	24" (610 mm) Diameter	Polymer Trays	1	24 lbs.	\$308.85
Shaft						Individual Pack
6370-96-7008-26-52	70½" Shaft with bushing	70½" (1791 mm) Length	Chrome	1	12 lbs.	\$60.45
Single Shelf Pantry Sets						Individual Pack
6221-20-**-52	Single Shelf D-Shape Tray	20" (508 mm) Diameter	Polymer Trays	1	5 lbs.	\$48.15
6421-18-**-52	Single Shelf Kidney Shape Tray	18" (457 mm) Diameter	Polymer Trays	1	5 lbs.	\$50.45
6421-24-**-52	Single Shelf Kidney Shape Tray	24" (610 mm) Diameter	Polymer Trays	1	6 lbs.	\$53.05

CONTAINS: (5) shelves, w/ (5) positioning base assemblies, mounting flange and jack screw. (Lower Shaft Sold Separately) - Includes Upper Shaft
NOTES: 1" (26 mm) diameter shaft system **Product available in two colors: 11 White & 15 Almond.

These pantry sets include 5 wood shelves with an independent rotating system. The shelves are available in 20" or 24" diameters.



4WLS221 - 20"



1VS20DLSF - 20"



4WLS421 - 24"

Special Order Items
Please allow two-week lead time.



TALL & PANTRY
ACCESSORIES

REV-A-SHELF®
Wood Classics™

PRODUCT #'s	DESCRIPTION	PRODUCT DIMENSIONS	FINISH	SET PER CARTON	WEIGHT PER CARTON	SUGGESTED LIST PRICE
5 Shelf Pantry Sets and Rotating Hardware, Shaft Sold Separately						Individual Pack
4265-20-50	5 Shelf D-Shape Set (no post)	20" (508 mm) Diameter	Wood	1	35 lbs.	\$547.95
1VS265-20-**-50	5 Shelf D-Shape Set (Vineyard)(no post)	20" (508 mm) Diameter	Wood	1	35 lbs.	\$1003.10
4465-24-50	5 Shelf Kidney Shape Set (no post)	24" (609 mm) Diameter	Wood	1	37 lbs.	\$633.95
Shaft						Individual Pack
6370-96-7008-26-52	70½" Shaft with bushing	70½" (1791 mm) Length	Chrome	1	12 lbs.	\$60.45
Single Shelf Pantry Sets						Individual Pack
4WLS221-20-52	Single Shelf D-Shape Set	20" (508 mm) Diameter	Wood	1	8 lbs.	\$99.75
1VS20DLSF-BS**	Single Shelf D-Shape Set (Vineyard)	20" (508 mm) Diameter	Wood	1	8 lbs.	\$184.15
4WLS421-24-52	Single Shelf Kidney Shape Set	24" (609 mm) Diameter	Wood	1	10 lbs.	\$127.90

CONTAINS: (5) shelves, w/ (5) positioning base assemblies, mounting flange and jack screw. (Lower Shaft Sold Separately) - Includes Upper Shaft
NOTES: 1" (26 mm) diameter shaft system **Product available in two colors: 22 Pewter & 23 Bronze.