

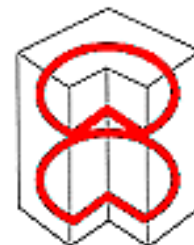

## Pie-Cut Cabinet Storage Organizer Model 6940 Installation Instructions and Adjustments



### Insufficient Side Clearance Adjustment



**Incorrect (unequal gaps)**

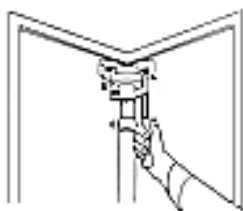

**Correct (equal gaps)**

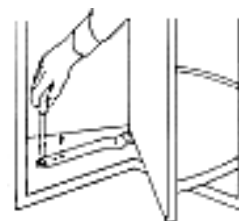

#### Step 1- Top Adjustment

1. Remove and discard shipping screws (if used).
2. Loosen star washer screws to re-center pivot. Tighten, check and repeat if necessary.

#### Step 2 Bottom Adjustment

1. Rotate door to expose screws on bottom bracket.
2. Remove and discard shipping screws (if used).
3. Loosen star washer screws to re-center pivot cam base (both sides). Tighten, check and repeat if necessary.

### Uneven or Incomplete Door Closing Adjustment (To center the doors correctly in the frame for proper clearance)



**Incorrect**

#### Step 1

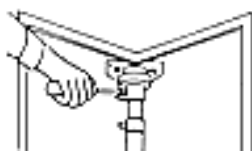

Loosen clamp screw in white plastic housing (approx. 1 turn) to prepare for positioning adjustment.

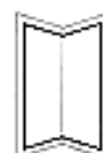

**Correct Front Centered Position**

#### Step 2

Rotate door counter-clockwise until white plastic housing has been latched into position with spring. A resistance to turning will be felt when the housing reaches the latched position and may be accompanied by a click or latching sound.

## Step 3

Rotate door slowly clockwise to exact front centered position but not past it. Release door to check alignment. You may need to rotate door a little past center to allow for slight spring-back. If you rotate too far, go back to step 2 and repeat.

## Step 4

**SLOWLY** rotate door counter-clockwise far enough so that clamp screw faces you again. Tighten clamp screw securely, being careful not to rotate white plastic housing out of position.

## Top/Bottom Clearance Adjustment



**Incorrect (unequal gaps)**



**Correct (equal gaps)**

## Step 1

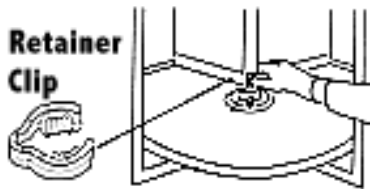

Remove polymer retainer clip.

## Step 2

Turn adjustment wheel (located inside cut out portion of shaft) clockwise to raise shelf/door unit. One full turn raises door 1/32". After adjustment, be sure to replace retainer clip.

## Notes:

1. If shelves are heavily loaded, lift lower shelf slightly to aid adjustment. Total adjustment 1/2".
2. When adjustments are completed, be sure to securely tighten all adjustment screws in housing, shaft bushing and tray adjustment screws.

## Cleaning and Lubricating

- Clean as needed with mild soap and lukewarm water.
- Any common household lubricant is acceptable.

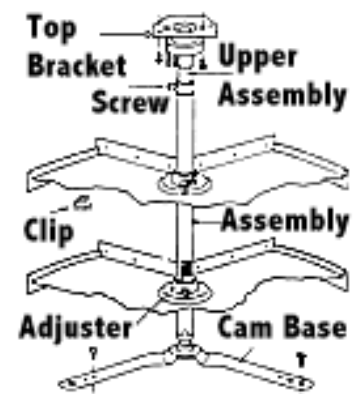

Should you encounter any problems or have any additional questions or requirements, please contact

our CUSTOMER SERVICE SPECIALIST at: **1-800-626-1126**